

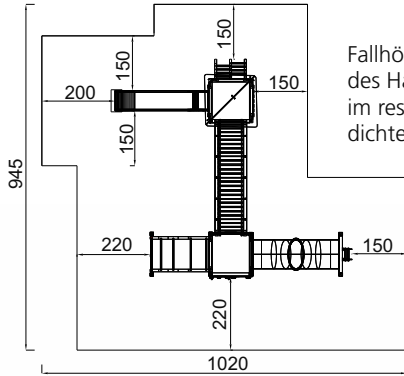

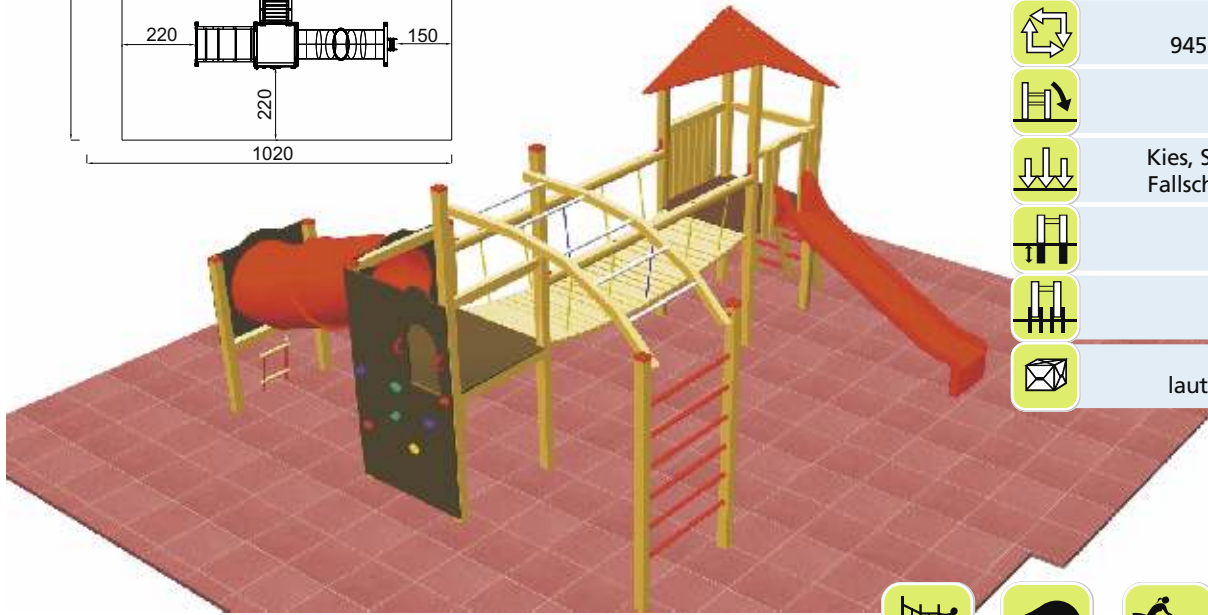







Art. B69130



Fallhöhe 250 cm nur im Bereich des Hangelbogens (27 m²), im restlichen Bereich ist dichter Rasen ausreichend.



-  3 - 10 Jahre
-  Large
-  595 x 649 x 305 cm
-  945 x 1.020 cm
-  250 cm
-  Kies, Sand, Rinde
Fallschutzplatten
-  70 cm
-  ja, möglich
-  laut Zeichnung

