









# Spielkombination SEBASTIAN



Art. B85060



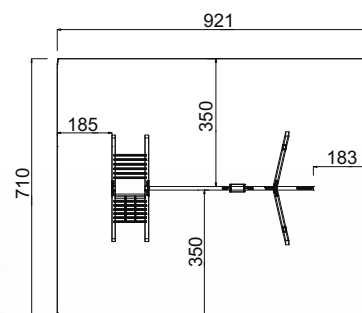





-  3 - 8 Jahre
-  Medium
-  551 x 244 x 215 cm
-  921 x 710 cm
-  200 cm
-  Kies, Sand, Rinde  
Fallschutzplatten
-  80 cm
-  ja, möglich
-  laut Zeichnung



# Spielkombination WERNER



Art. B85065

-  3 - 8 Jahre
-  Medium
-  477 x 244 x 215 cm
-  812 x 710 cm
-  200 cm
-  Kies, Sand, Rinde  
Fallschutzplatten
-  80 cm
-  ja, möglich
-  laut Zeichnung

